

Bedienungsanleitung Bedrijfsvoorschrift Operating instructions Instruccions d'utilisacion Instrucciones de servicio
Istruzioni per l'uso Instruções de funcionamento Használati útmutató Instrukcja obsługi
Руководство по эксплуатации Käyttöohje Návod na obsluhu Návod k použití Navodila za uporabo

RUS Ёмкость для водопада 28,5 см



Meßner®

130/003313

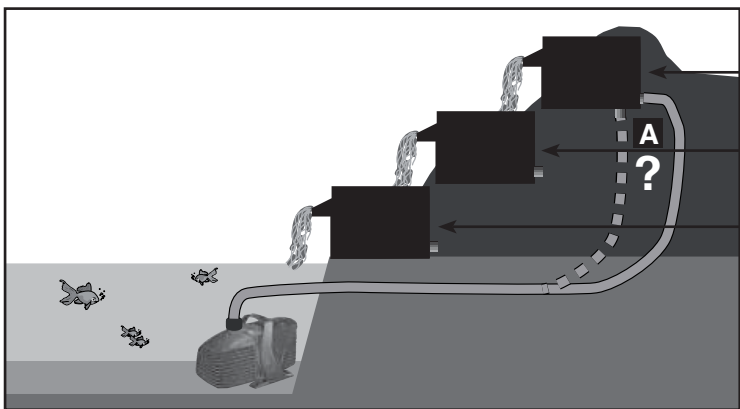
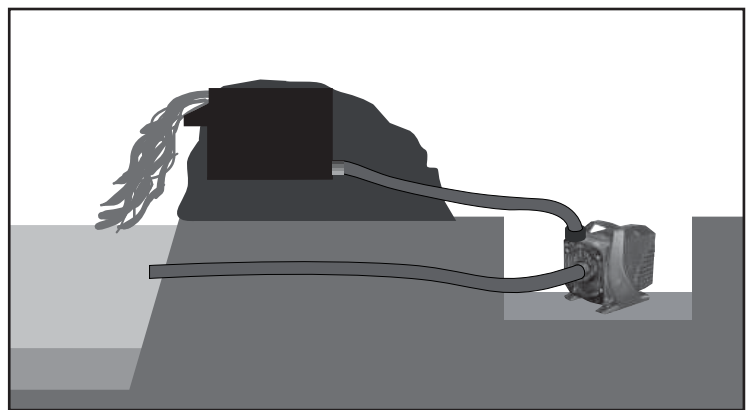
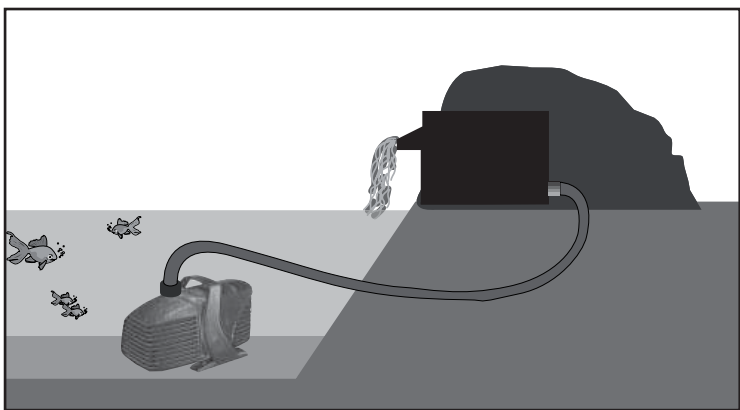
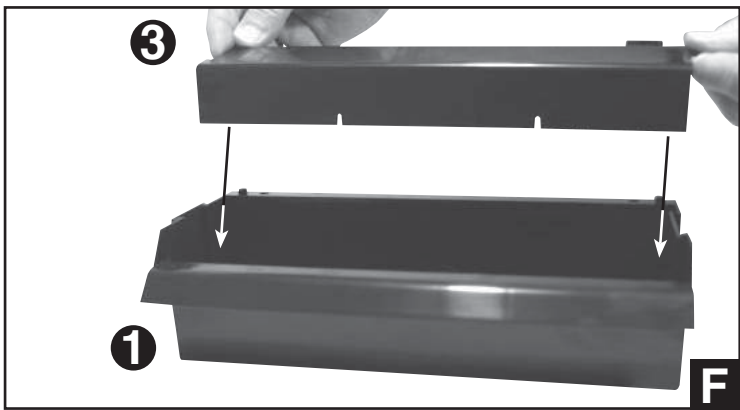
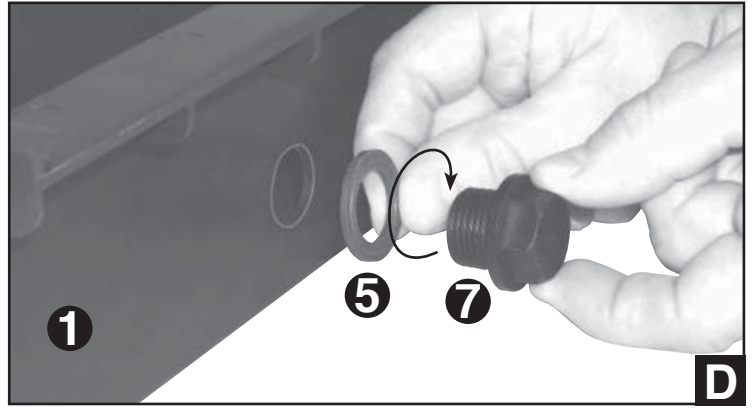
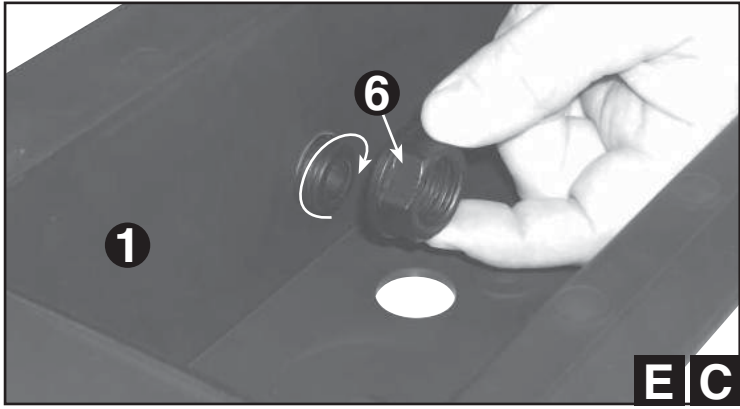
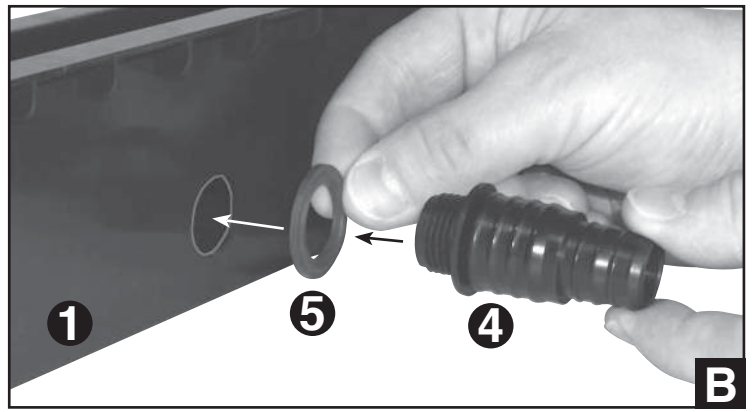
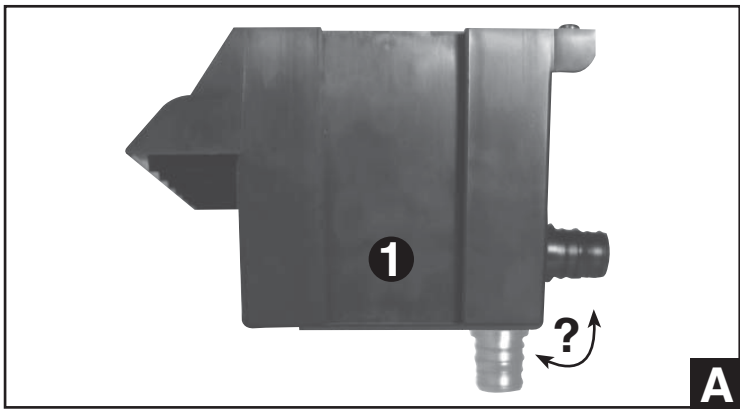

Fig. **A** **B** **C** **D** **E** **F** **G** **[H I J K]**

2 x D **2 x E** **[H I J K]** **L** **M**

