

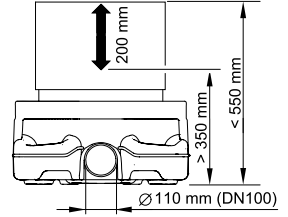

PROFISKIM 100

DE	Gebrauchsanleitung
GB	Operating instructions
FR	Notice d'emploi
NL	Gebruiksaanwijzing
ES	Instrucciones de uso
PT	Instruções de uso
IT	Istruzioni d'uso
DK	Brugsanvisning
NO	Bruksanvisning
SE	Bruksanvisning
FI	Käyttöohje
HU	Használati útmutató
PL	Instrukcja użytkowania
CZ	Návod k použití
SK	Návod na použitie
SI	Navodila za uporabo
HR	Uputa o upotrebi
RO	Instrucțiuni de folosință
BG	Упътване за употреба
UA	Посібник з експлуатації
RU	Руководство по эксплуатации
CN	使用说明书

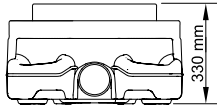

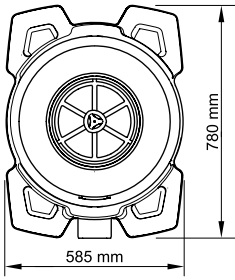

Gravitation		= 8000 - 12000 l/h
Pump		= 8000 - 20000 l/h



A

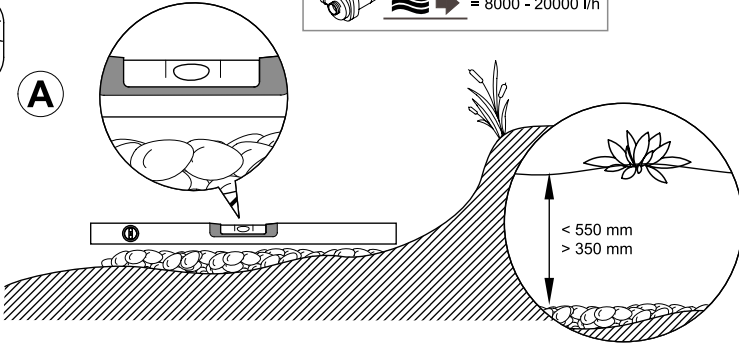

B

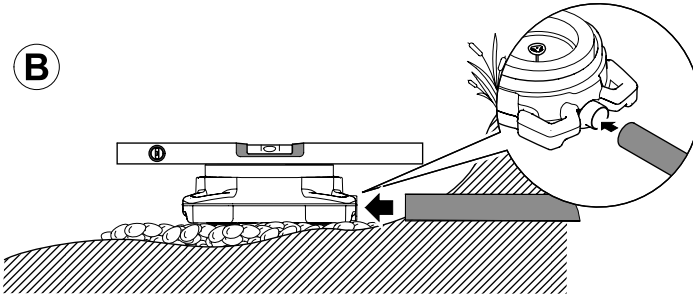

C

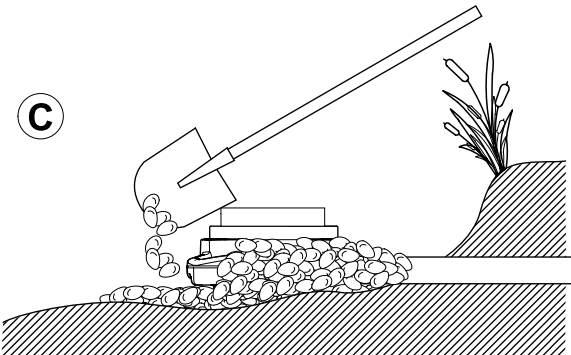



D

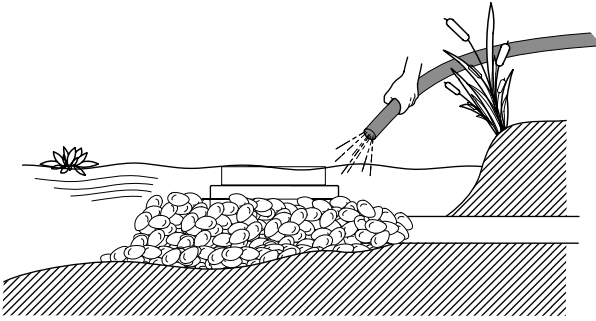

E

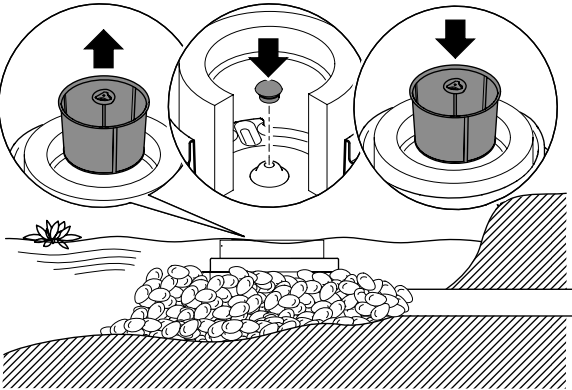

A

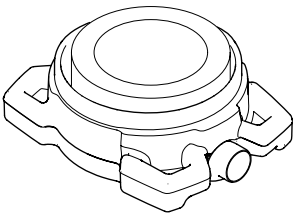
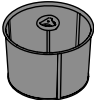

B



C

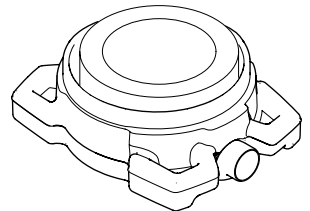
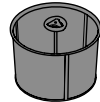

Profiskim 100	
Pos.	
1	12787
2	28037
3	28036
4	27844

